



ROLLICOOL™

PORTABLE AIR CONDITIONER



USER MANUAL

SAVE THIS MANUAL FOR FUTURE REFERENCE



www.rollibot.com

Customer Service: 1-844-585-6295

Dear Rollibot RolliCool Owner,

Welcome to the new age of cool!

The RolliCool COOL100 is an AC unit that uses the latest technology to improve your quality of life. We've designed this unit to be fully portable and easy to use in your home. It features multiple modes to keep you cool no matter what the weather's like!

The COOL100 is designed for indoor use and can be used in different sized spaces. Casters make it easy to move the AC unit from room to room so you can stay cool anywhere. There's even a remote control for a little more convenience!

All of the unit's features are available through the RolliCool app. After paring your AC unit and your smartphone, stay cool however you like!

Thank you for being a part of the Rollibot family!

— The RolliBot Team

Table of Contents

- Section 1. Information & Safety Warnings 5**
- 1.1 – Introduction 5
- 1.2 – Safety Warnings 5
- 1.3 – FCC Information 6
- 1.4 – Disposal at End-of-Life 6
- Section 2. RolliCool Parts 7**
- 2.1 – Box Contents 7
- 2.2 – Components Overview 7
- 2.3 – Control Panel 8
- 2.4 – Remote Overview 10
- Section 3. Setting Up the Unit 10**
- Section 4. App Setup 11**
- Section 5. How to Use the RolliCool 12**
- 5.1 – Cool Mode 12
- 5.2 – Dehumidify Mode 12
- 5.3 – Fan Only Mode 13
- 5.4 – Timer 13
- 5.5 – Sleep Mode 14
- Section 6. Maintenance 14**
- 6.1 – How to Clean the Filters 14
- 6.3 – How to Drain the Unit 15
- Section 7. Storage 16**
- Section 8. Troubleshooting 16**
- Section 9. Warranty 17**
- 9.1 – Violation 17
- 9.2 – Information 17

Section 1. Information & Safety Warnings

1.1 – Introduction

This user manual will guide you through the functions and usage of your RolliCool Portable Air Conditioner. It is important that you follow all instructions and pay attention to all notes that appear throughout this manual. Consult this manual before you attempt to use your RolliCool. If you have questions not answered by this manual or are in need of repair or non-routine service, contact customer service at 1-844-585-6295. Before contacting customer service, please have your purchase information ready as this may be needed during the call. This information may be recorded below.

Date of Purchase: _____

Place of Purchase: _____

1.2 – Safety Warnings

When reading this manual, note these icons:

 Notes with this icon **MUST** be read, understood, and obeyed to prevent injury or damage etc.

 Notes with this icon include relevant information.

Overall Usage

- Do not insert objects into the product.
- The product is not a toy. Do not leave children unsupervised around the product.
- The product is designed for indoor use only.
- Keep the product upright at all times.
- Do not use the product near any of the following places:
 - Near anything flammable
 - Direct sunlight
 - Damp areas
 - Dusty areas
- Do not use wax, thinner, or solvents when cleaning the air conditioner.
- Clean your filter once or more every couple of weeks.
- Do not place any obstacles in front of the inlet.
- Do not pull the power lines.
- In the event that the product is malfunctioning, shut the power off immediately.
- Switch off the product before cleaning.
- Use only two AA batteries. Do not mix old and new batteries or batteries from different brands.
- You should only use parts you have received from RolliBot™ or that have been included in the original packaging.
- Do not use the product for any purpose other than described in this user manual.

Installation Warnings

- Do not install the product in a sloped setting.
- Do not install the product in direct sunlight.
- Do not install the product in places with open flames or flammable gas.

- Do not use extension cords etc. Only plug the product into a grounded wall outlet.
- Avoid installing the product in damp areas.
- Make sure to drain the RolliCool with the included drainage pipe.

1.3 – FCC Information

DECLARATION OF CONFORMITY:

This device complies with Part 15 of the FCC Rules.

Operation is subject to the following two conditions: (1) This device may not cause harmful interference, and (2) this device must accept any interference received, including interference that may cause undesired operation.

FCC RELATED INFORMATION:

This equipment has been tested and found to comply with the limits for a Class B digital device, pursuant to Part 15 of the FCC Rules. These limits are designed to provide reasonable protection against harmful interference in a residential installation. This equipment generates, uses, and can radiate radio frequency energy and, if not installed and used in accordance with the instructions, may cause harmful interference to radio communications. However, there is no guarantee that interference will not occur in a particular installation. If this equipment does cause harmful interference to radio or television reception, which can be determined by turning the equipment off and on, the user is encouraged to try to correct the interference by one or more of the following measures:

- Reorient or relocate the receiving antenna.
- Increase the separation between the equipment and receiver.
- Connect the equipment into an outlet on a circuit different from that to which the receiver is connected.
- Consult the dealer or an experienced radio/TV technician for help.

The manufacturer is not responsible for any radio or TV interference caused by unauthorized modifications to this equipment. Such modifications could void the user's authority to operate the equipment.

1.4 – Disposal at End-of-Life

This product must not be disposed of by incineration, landfilling, or mixing with household trash. Improper disposal of the battery contained within this product may result in the battery heating up, rupturing, or igniting which may cause serious injury. The refrigerants contained inside the RolliCool present chemical risks to the environment. The recommended disposal for any RolliCool Portable Air Conditioner at its end-of-life is to dispose of the entire unit by contacting your local recycling company. Local regulations and laws pertaining to the recycling and disposal of any RolliCool unit and/or products containing them will vary according to your country, state, and local governments. You must check laws and regulations corresponding to where you live in order to dispose of your RolliCool unit properly. It is the user's responsibility to dispose of their equipment properly in accordance with local regulations and laws.

For additional information about where you should drop off your RolliCool unit, please contact your local or regional waste management office, your household waste disposal service, or your point-of-sale.

Section 2. RolliCool Parts

2.1 – Box Contents

- 1 x RolliCool Portable AC
- 1 x Remote Control
- 1 x Drainage Pipe
- 3 x Air Filter (pre-installed)
- 1 x Heat Exhaust Pipe
- 1 x Window Kit

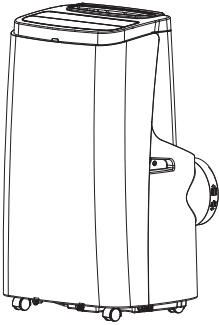

RolliCool Portable AC COOL 100



Remote Control

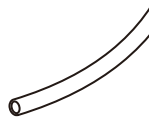

Drainage Pipe

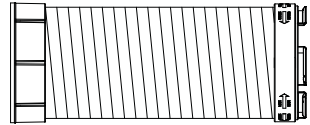

Heat Exhaust Pipe



Window Kit

2.2 – Components Overview

- 1 Control Panel
- 2 Front Housing
- 3 Castor
- 4 Air Outlet

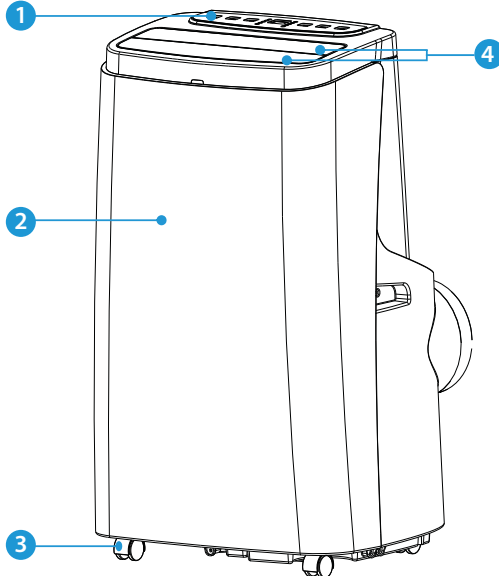

- 5 Upper Filter
- 6 Air Vent
- 7 Lower Filter
- 8 Lower Drainage Opening
- 9 Handle
- 10 Upper Drainage Opening
- 11 Power Cord Fixture
- 12 Air Inlet
- 13 Power Cord
- 14 Power Cord Plug

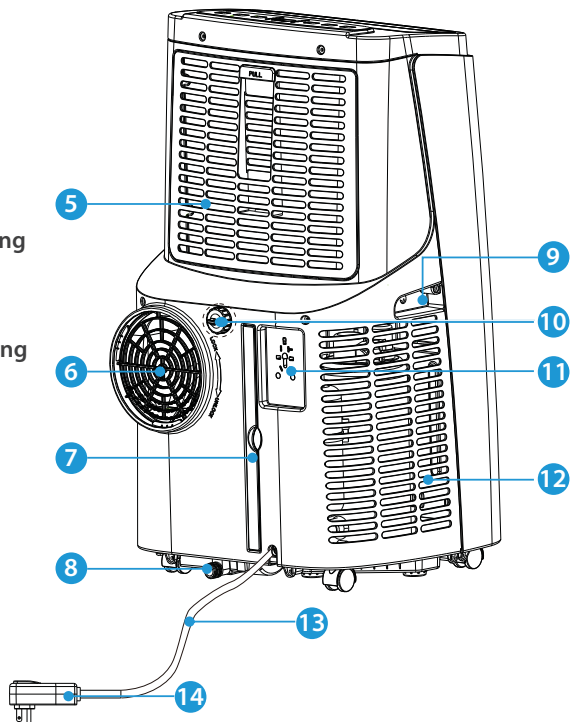

2.3 – Control Panel

The RolliCool Portable AC features a LCD Control Panel which turns on when the AC unit turns on and includes buttons.

BUTTONS & PARTS

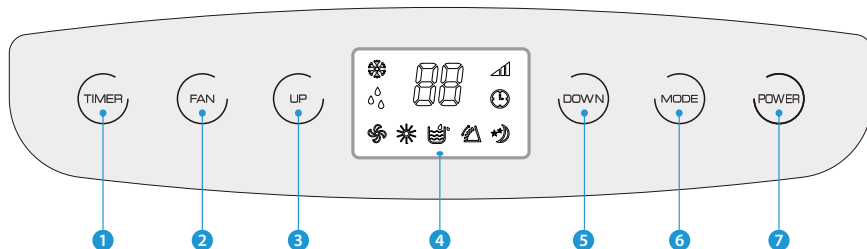

- 1 **Timer Button:** Press to begin setting a time for shut off or turn on.
- 2 **Fan Button:** Press to turn on Fan Only Mode and cycle through 3 fan speeds.
- 3 **Up Button:** Press to raise temperature (Cool Mode) or adjust timer duration.
- 4 **Display:** This section will light up to show temperature and other information.
- 5 **Down Button:** Press to lower temperature (Cool Mode) or adjust timer duration.
- 6 **Mode Button:** Press to cycle between Cool, Dehumidify, and Fan Only modes.
- 7 **Power Button:** Press to turn the unit on or off.

DISPLAY ICONS

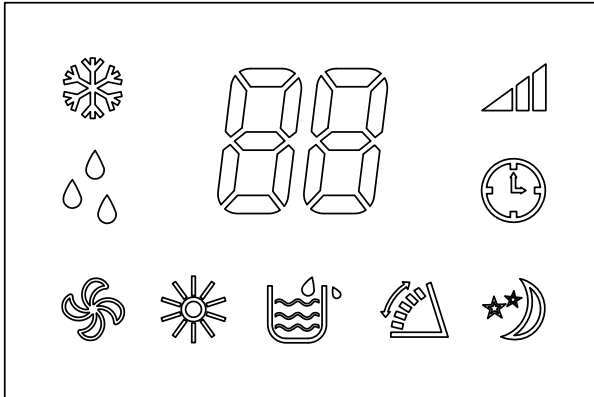

Cool Mode: This icon will light up when the unit is in Cool Mode.



Dehumidify Mode: This icon will light up when the unit is in Dehumidify Mode.



Fan Only Mode: This icon will light up when the unit is in Fan Only Mode.



Full: This icon will light up when the unit is full of water.



Timer Mode: This icon will light up when the timer has been programmed.



Sleep Mode: This icon will light up when the unit is in Sleep Mode.



- Scheduling can be done and/or adjusted via the Control Panel, remote, or the app. See the following section for more information about the remote. See Section 4 for information about the app.
- Press the Up and Down Button together on the Control Panel to switch between Celsius and Fahrenheit.

2.4 – Remote Overview

The RolliCool Portable AC features a remote with a digital display which may be used with the unit.

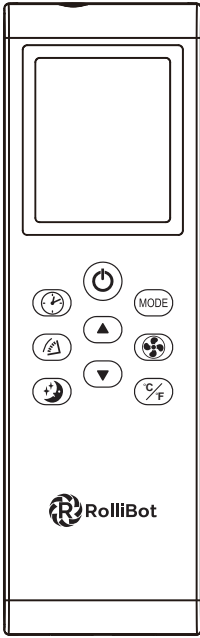

REMOTE BUTTONS



Timer Button: Press to begin setting a time for shut off or turn on.



Vent Button: Press to turn open or close the Air Outlet.



Sleep Button: Press to turn on Sleep Mode.



Power Button: Press to turn the unit on or off.



Up Button: Press to raise temperature (Cool Mode) or adjust timer duration.



Down Button: Press to lower temperature (Cool Mode) or adjust timer duration.

MODE

Mode Button: Press to cycle between Cool, Dehumidify, and Fan Only modes.



Fan Speed Button: Press to cycle through 3 fan speeds.



C/F Button: Press to switch between Celsius and Fahrenheit.



- Avoid pressing two buttons simultaneously as this may cause malfunctions.
- Avoid using the remote in areas with extreme temperature fluctuations.
- If the remote will not be used for extended periods of time, remove the battery.
- The remote control's range is approximately 23 ft. Use it within this range.
- Use only two AA batteries. Do not mix old and new batteries or batteries from different brands.

Section 3. Setting Up the Unit



- Before using the unit, keep it upright for at least two hours.
- Do not use extension cords etc. Only plug the unit into a grounded wall outlet.
- Do not use the unit in bathrooms or other excessively humid environments.
- After installation, keep the unit at least 20 in. from the walls at all times.

Step 1. Attach the wheels (if needed) and roll the unit into the desired room. In the moving process, ensure that the unit is in an upright position and the RolliCool is placed on a flat surface.

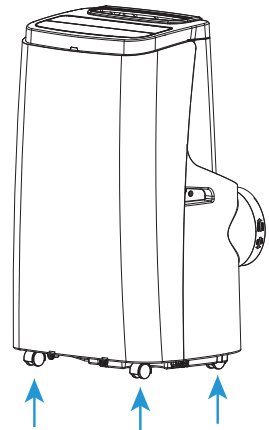

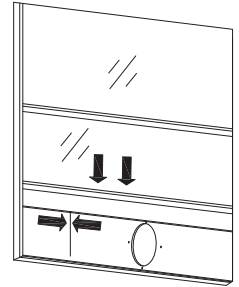
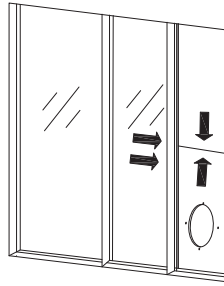
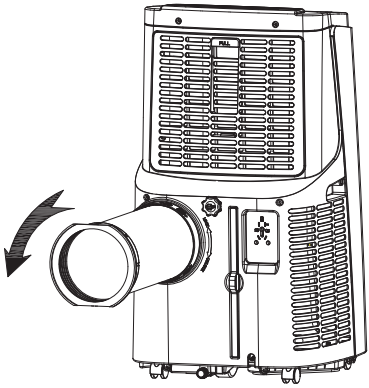

Step 2. Attach the included Heat Exhaust Pipe to the Air Vent on the back of the unit. Unfold the pipe to the necessary length.

Step 3. Install the Window Kit into a gap between the window and the frame. Adjust as needed.

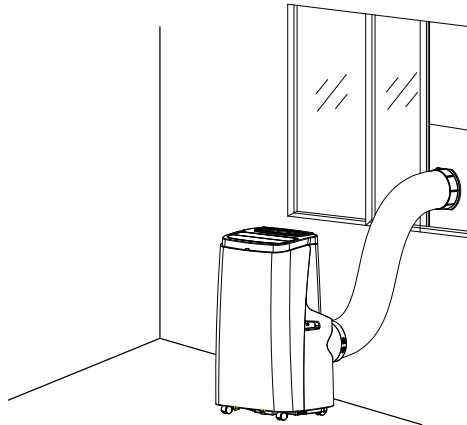

Step 4. Attach the Heat Exhaust Pipe to the Window Kit.

Section 4. App Setup

For your convenience, there is an app for the RolliCool. The app is compatible with most Android and iOS smartphones. The app can be used to set cooling schedules, change modes, and more. Use your smartphone to search the Play or App Store for the “RolliCool” application then download and install the app according to your operating system.



- Either wi-fi or Bluetooth® may be used for setup.
- Powering on the RolliCool will automatically enable Bluetooth® i.e. Bluetooth® will become enabled and stay enabled as long as the RolliCool is turned on.
- For instructions on how to turn on Bluetooth®, consult materials for your Bluetooth®-enabled smartphone.
- As with most Bluetooth® devices, it is recommended to keep the connected devices at least 32 ft. within each other. The

connection may be terminated or fail to work properly if the connected devices are too far apart.

Section 5. How to Use the RolliCool

The RolliCool Portable AC features a number of ways to keep cool and comfortable. Most features can be used by pressing the buttons on the unit's Control Panel, the remote, or via the app.

 *In most cases where the remote can be used, the app can also be used as a substitute.*

5.1 – Cool Mode

With this mode, the unit will turn on and regulate temperature as selected.

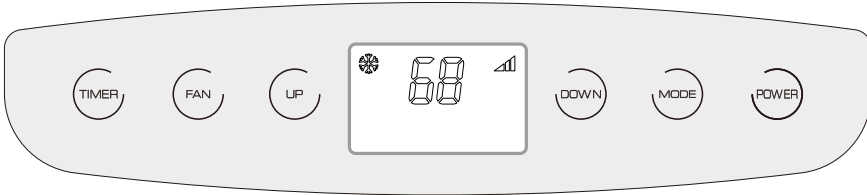

1. Press the Power Button on the Control Panel or the remote.
2. Press the Mode Button on the Control Panel or the remote until the Cool Mode icon appears. Press it multiple times to cycle through different modes.
3. Use the Up and Down Buttons to set the desired temperature 61~88°F (16~31°C).
4. Use the Fan Button to change fan speed. Press it multiple times to cycle through speeds.

 *When Cool Mode is active, the unit will not turn on if the chosen temperature is higher than the indoor temperature.*

5.2 – Dehumidify Mode

With this mode, the unit will turn on and begin removing moisture from the air.

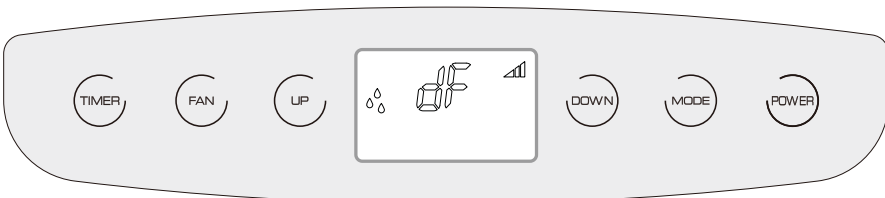

1. Press the Power Button on the Control Panel or the remote.
2. Press the Mode Button on the Control Panel or on the remote until the Dehumidify Mode icon appears. Press it multiple times to cycle through different modes.

 *In Dehumidify Mode, the fan speed is automatically set to low and cannot be adjusted.*

5.3 – Fan Only Mode

With this mode, the unit will turn on and begin using the fan to promote air circulation.

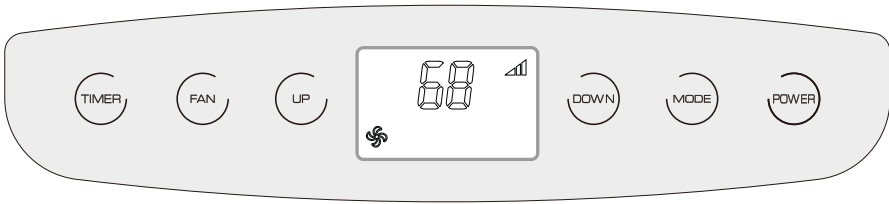

1. Press the Power Button on the Control Panel or the remote.
2. Press the Mode Button on the Control Panel or the remote until the Fan Only Mode icon appears.
3. Use the Fan Button to begin changing fan speed. Press it multiple times to cycle through speeds.

5.4 – Timer

With this mode, the unit will automatically turn on or off and regular temperature according to the selected times.

- *Setting the schedule when the unit is off means setting the time the unit will turn on.*
- *Setting the schedule when the unit is on means setting the time the unit will run before it shuts off.*
- *After setting the timer, the AC unit will enter Timer Mode. While the unit is in Timer Mode, it will operate according to the selected timer duration. Pressing the Timer Button again may cancel a timer program.*

TO SET A TURN ON TIME

1. When the unit and remote are off, press the Timer Button on the Control Panel or the remote.
2. Use the Up and Down Buttons to select the time the AC unit will turn on i.e. selecting "03" will prompt the unit to turn on in 3 hours' time etc.
3. After the selection is complete, the display will show the Timer icon.

- *When a schedule is active, the unit will not turn on if the chosen temperature is higher than the indoor temperature.*
- *The AC unit will automatically turn off after 2 hours.*

TO SET A SHUTOFF TIME

1. When the unit and remote are on, press the Timer Button on the Control Panel or the remote.
2. Use the Up and Down Buttons to select the time the AC unit will turn off i.e. selecting "03" will prompt the unit to turn off in 3 hours' time etc.
3. After the selection is complete, the display will show the current indoor temperature and the Schedule Light.

5.5 – Sleep Mode

With this mode, the unit will turn on and begin operating at a low speed. This mode is similar to Fan Only Mode at low fan speed and functions as a way to aid sleep especially if you are used to light noise around bedtime.

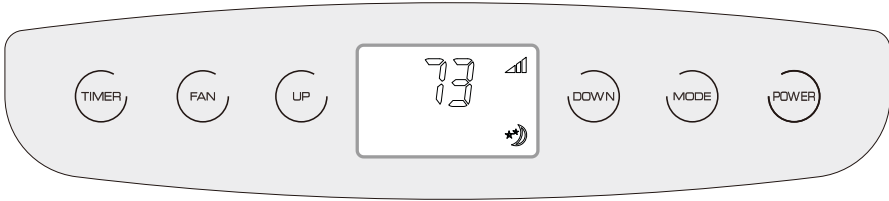

1. Press the Power Button on the Control Panel or the remote.
2. Press the Fan Only and Up Buttons together on the Control Panel or the Sleep Mode button on the remote.

 *In Sleep Mode, the fan speed is automatically set to low and cannot be adjusted.*

Section 6. Maintenance

Proper maintenance will help improve your RolliCool's performance. Periodically, the RolliCool will need its filters cleaned. For optimal performance, the filters should be cleaned at least twice a month.

-  *If any type of non-routine maintenance is needed, such as any maintenance not described in Section 6 of this manual, please contact customer service or a certified HVAC professional as the unit contains refrigerant.*
- Wipe the exterior clean with non-abrasive cloth. If needed, cloth can be dampened with water.*
- Do not use harsh chemicals to clean as these may damage the unit.*

6.1 – How to Clean the Filters

-  *Please make sure your AC unit is completely powered off before performing any type of maintenance.*
- Do not scrape the air filters as it may sustain damage.*
- A hand vacuum or low-powered vacuum or vacuum modes may be used to clean the filters.*
- Replace the filters after cleaning. Do not use the RolliCool without the filters.*
- DO NOT wash or allow the carbon filter (the black filter) to come in contact with any type of water or liquid.*
- If water has been used to clean any filter, ensure it is completely dried before reinstalling. Do NOT dry any filter in direct sunlight.*

CLEANING THE UPPER FILTER

1. Reach under the notch and remove the screen cover.
2. Using a screwdriver, remove the four screws from the filter.

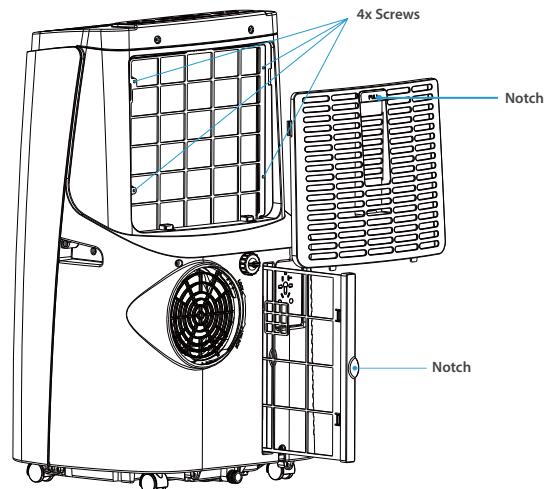

3. Remove the filter and soak it in lukewarm water or use a vacuum to clean the filter. Mild detergents may be used.
4. After the filter has completely dried, reinstall it.

CLEANING THE LOWER FILTER

1. Reach under the notch and remove the filter.
2. Soak it in lukewarm water or use a vacuum to clean the filter. Mild detergents may be used.
3. After the filter has completely dried, reinstall it.

6.3 – How to Drain the Unit

In most cases, the AC unit will not require draining. If this is necessary in some special case, the unit will sound an alarm and the display will show the icon  to indicate the water reservoir inside is full.



- Please make sure your AC unit is completely powered off before performing any type of maintenance.
- If relocating the unit before draining, move it carefully so as not to spill the water inside the reservoir.
- Make sure the Drainage Pipe, has adequate space underneath for draining. If using the Lower Drainage Opening, ensure there is a suitable area for water runoff. If using the Upper Drainage Opening, fetch a container for water runoff before connecting the pipe.
- Keep the drainage cover and the water plug on at all times when not draining the unit.
- When draining the unit, do not allow the Power Cord to come in contact with water.
- During drainage, the unit may be tilted slight backwards to promote faster drainage.
- Keep in mind the unit may hold more water than expected. If using a container, do not use a small one or either take care of drainage outdoors.

USING THE LOWER DRAINAGE OPENING

1. Turn off and unplug the unit.
2. Move the unit to a suitable location for drainage.
3. Remove the cap from the opening.
4. Allow the water to drain.
5. After draining is complete, it is recommended to turn the unit on and run it in Fan Only Mode at the lowest speed for at least two hours in order to ensure the Drainage Pipe dries inside.
6. Reinstall the cap.

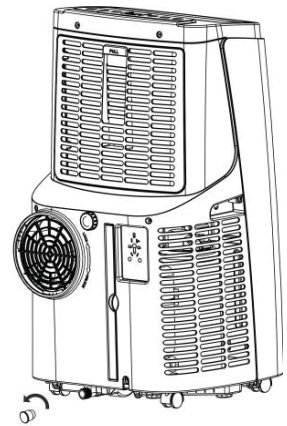

USING THE UPPER DRAINAGE OPENING

1. Turn off and unplug the unit.
2. Move the unit to a suitable location for drainage if needed.
3. Place a container near the unit.
4. Place the end of the Drainage Pipe in the container.

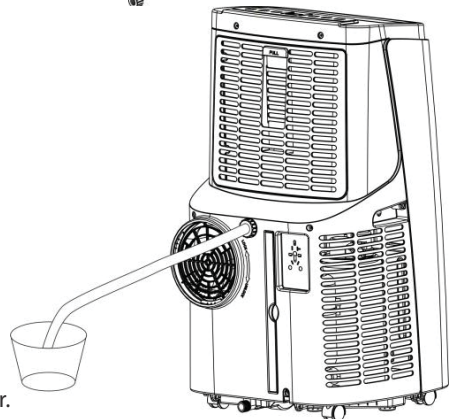

5. Remove the cap from the opening.
6. Connect the Drainage Pipe to the unit.
7. Allow the water to drain.
8. After draining is complete, it is recommended to turn the unit on and run it in Fan Only Mode at the lowest speed for at least two hours in order to ensure the Drainage Pipe dries inside.
9. Detach the pipe.
10. Reinstall the cap.

Section 7. Storage

Before storing your RolliCool Portable AC, select a dry, indoor environment. Properly storing your RolliCool will help improve performance and battery life expectancy.

- Step 1.** Turn the AC unit off.
- Step 2.** Remove the Heat Exhaust Pipe and Window Kit as needed for storage with the unit.
- Step 3.** Drain the unit of any water and insure all parts are completely dry.
- Step 4.** Turn the unit on and run it in Fan Only Mode at the lowest speed for at least two hours in order to ensure the inner reservoir is dried inside.
- Step 5.** Turn off the unit and install the Power Cord's plug into its fixture on the back of the unit.
- Step 6.** Remove the remote batteries and store separately.



- *Always turn the unit off before transporting or storing.*
- *Cover the unit to protect it from dust. Do not store in a dusty environment as, with all electronic devices, dust may cause damage over time.*
- *Store the unit indoors at a dry and stable temperature. Do not store in an unheated garage, shed, or other locations with extreme temperature fluctuations.*

Section 8. Troubleshooting

Problems	Possible Causes	Solution(s)
The unit does not work.	There is no electricity.	Turn it on after connecting it to a socket with electricity.
	The overflow indicator displays.	Drain the water inside.
	The indoor temperature is too low or too high.	Use the unit when the indoor temperature is between 44-95 °F (7-35 °C).
		Change the set temperature.

Problems	Possible Causes	Solution(s)
The cooling effect is weak.	There is direct sunlight.	Cover any direct sunlight coming through the windows.
	Doors or windows are open; there are a lot of people; or there are other sources of heat.	Close doors and windows.
	The filter is dirty.	Clean or replace the filter.
	The air inlet or outlet is blocked.	Clear obstructions.
Excessive Noise	The unit is not placed on a flat surface.	Put the unit on a flat and stable surface.
Compressor issues	Overheating protection started.	Wait 3 minutes until the temperature is lowered then restart the unit.
The remote control does not work.	The remote and unit are too far apart.	Get closer to the RolliCool and make sure that the remote control directly faces the unit.
	The remote isn't pointed in the right direction.	
	Batteries are dead.	Replace batteries.

When the RolliCool encounters errors, the display may show certain error codes. Refer to the table below.

Code	Possible Cause	Solution(s)
E1	Indoor temp. sensor failure.	Contact customer service for troubleshooting.
E2	EVA sensor failure	Contact customer service for troubleshooting.

If none of the above information resolves your issue, please visit our website at www.rollibot.com or contact customer service at 1-844-585-6295.

Section 9. Warranty

9.1 – Violation

The RolliCool Portable Air Conditioner cannot be repaired or serviced within its warranty period if any of the following has occurred:

- The warranty has expired
- Damage occurred during or in relation to non-routine and/or unauthorized disassembly
- Failure to provide a valid proof of purchase when requesting service or repair
- Damage occurred as a result of natural disaster etc.
- Damage occurred due to unexpected factors or man-made reasons (including mis-operation, fluid found in any openings, improper insertion or pulling, hauling, bumping, improper voltage input and others)

9.2 – Information

ONE YEAR LIMITED HARDWARE WARRANTY

Your RolliCool Portable Air Conditioner (“Product”) includes a One Year Limited Hardware

Warranty (“Warranty”). The Warranty covers product defects in materials and workmanship under normal use. This Warranty is limited to residents of the United States and Canada only and is available only to original purchasers. This Warranty gives you specific legal rights, and you may also have other rights which vary from state to state.

This Warranty starts on the date of your purchase and lasts for one year (the “Warranty Period”). The Warranty Period is not extended if the Product is repaired or replaced. We may change the availability of this limited warranty at our discretion, but any changes will not be retroactive.

Warranty services are provided by Warranty Pro (“WP”). If a hardware defect arises and a valid claim is received within the Warranty Period, at its option and to the extent permitted by law, WP will: (1) repair the hardware defect by using new or refurbished parts that are equivalent to new in performance and reliability; or (2) exchange the Product with a product that is new or refurbished which is substantially equivalent to the original product. This Warranty is for one replacement only of like-items and does not cover items out of production if the product is no longer made or stocked. This Warranty is not assignable or transferable. The original purchaser may call WP’s toll-free number at 1-844-585-6295 for a service request.

When a product or part is exchanged, any replacement item becomes your property, and the replaced item becomes WP’s property. This warranty only covers technical hardware defectiveness during the warranty period and under normal use conditions. WP does not warrant uninterrupted or error-free operation of this Product.

This Warranty does not cover any damage due to: (a) transportation; (b) storage; (c) improper use; (d) failure to follow the product instructions or to perform any preventive maintenance; (e) modifications; (f) unauthorized repair; (g) normal wear and tear; or (h) external causes such as accidents, abuse, or other actions or events beyond our reasonable control.

Important: Do not disassemble the Product. Disassembling the Product will void this Warranty. Only WP or a party expressly authorized by WP should perform service on this Product.

DISCLAIMER OF WARRANTY: THE REMEDIES DESCRIBED ABOVE ARE YOUR SOLE AND EXCLUSIVE REMEDIES AND OUR ENTIRE LIABILITY FOR ANY BREACH OF THIS LIMITED WARRANTY. OUR LIABILITY SHALL UNDER NO CIRCUMSTANCES EXCEED THE ACTUAL AMOUNT PAID BY YOU FOR THE DEFECTIVE PRODUCT, NOR SHALL WE UNDER ANY CIRCUMSTANCES BE LIABLE FOR ANY CONSEQUENTIAL, INCIDENTAL, SPECIAL OR PUNITIVE DAMAGES OR LOSSES, WHETHER DIRECT OR INDIRECT.

SOME STATES DO NOT ALLOW THE EXCLUSION OR LIMITATION OF INCIDENTAL OR CONSEQUENTIAL DAMAGES, SO THE ABOVE LIMITATION OR EXCLUSION MAY NOT APPLY TO YOU.

THE DURATION AND REMEDIES OF ALL IMPLIED WARRANTIES, INCLUDING WITHOUT LIMITATION THE WARRANTIES OF MERCHANTABILITY AND FITNESS FOR A PARTICULAR PURPOSE ARE LIMITED TO THE DURATION OF THIS EXPRESS LIMITED WARRANTY

